



## *Specification for Approval*

- DEVICE NUMBER: BL-HJXGXBX32N

SAMPLES  
ATTACHED AREA

DATE \ PAGE	1	2	3	4	5	6	7	8	9			CONTENTS
2018/9/5	1.0	1.0	1.0	1.0	1.0	1.0	1.0	1.0	1.0	1.0		Initial Released

**FOR CUSTOMER'S APPROVAL STAMP OR SIGNATURE**

APPROVED	PURCHASE	MANUFACTURE	QUALITY	ENGINEERING

佰鴻工業股份有限公司  
 BRIGHT LED ELECTRONICS CORP.  
 新北市板橋區和平路 19 號 3 樓  
 3F., No.19, He Ping Road,  
 Ban Qiao Dist., New Taipei City,  
 Taiwan  
 Tel: +886-2-29591090  
 Fax: +886-2-29547006/29558809  
[www.brtled.com](http://www.brtled.com)

ISSUED	APPROVED	PREPARED
張孝嚴	陳悌帆	熊燦芬

### ● Features:

1. Emitted Color: Red, Blue and Green.
2. Lens Appearance: Water Clear.
3. 3.5x2.8x1.3 mm standard package.
4. Suitable for all SMT assembly methods.
5. Compatible with infrared and vapor phase reflow solder process.
6. Compatible with automatic placement equipment.
7. This product doesn't contain restriction Substance, comply ROHS standard.

### ● Applications:

1. Automotive lighting.
2. Backlighting: LCDs, Key pad advertising.
3. Status indicators: Consumer & industrial electronics.  
General use.

### ● Package Dimensions:

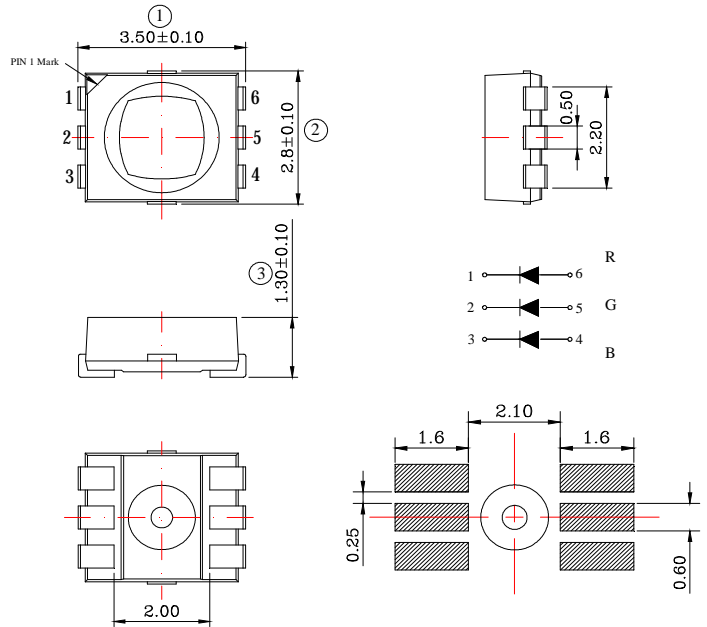

### NOTES:

1. All dimensions are in millimeters (inches).
2. Tolerance is  $\pm 0.10$  mm ( $0.004$ " ) unless otherwise specified.
3. Specifications are subject to change without notice.

### ● Absolute Maximum Ratings(Ta=25°C)

Parameter	Symbol	Color	Rating	Unit
Power Dissipation	P <sub>D</sub>	Blue	110	mW
		Green	110	
		Red	75	
Forward Current	I <sub>F</sub>		30	mA
Peak Forward Current* <sup>1</sup>	I <sub>FP</sub>		100	mA
Reverse Voltage	V <sub>R</sub>		5	V
Operating Temperature	Topr		-40°C ~ 85°C	-
Storage Temperature	Tstg		-40°C ~ 100°C	-
Soldering Temperature	Tsol		See Page 7	-

\*<sup>1</sup>Condition for I<sub>FP</sub> is pulse of 1/10 duty and 3 msec width.

### ● Electrical and optical characteristics(Ta=25°C)

Parameter	Symbol	Condition	Color	Min.	Typ.	Max.	Unit
Forward Voltage	$V_F$	$I_F=20mA$	Blue	2.8	3.1	3.6	V
			Green	2.8	3.0	3.6	
			Red	1.8	2.0	2.4	
Luminous Intensity	$I_v$	$I_F=20mA$	Blue	-	400	-	mcd
			Green	-	1900	-	
			Red	-	800	-	
Peak Wavelength	$\lambda_p$	$I_F=20mA$	Blue	-	470	-	nm
			Green	-	525	-	
			Red	-	630	-	
Dominant Wavelength	$\lambda_d$	$I_F=20mA$	Blue	460	-	475	nm
			Green	520	-	530	
			Red	619	-	630	
Spectral Line Half-width	$\Delta \lambda$	$I_F=20mA$	Blue	-	30	-	nm
			Green	-	30	-	
			Red	-	15	-	
Reverse Current	$I_R$	$V_R=5V$		-	-	10	$\mu A$
Viewing Angle	$2\theta_{1/2}$	$I_F=20mA$		-	120	-	degree

### ● Typical Electro-Optical Characteristics Curves

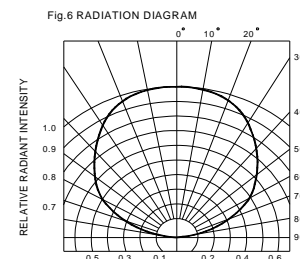
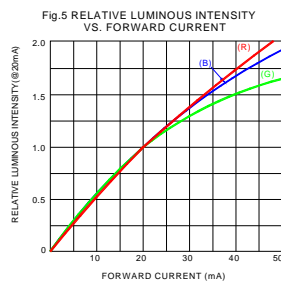
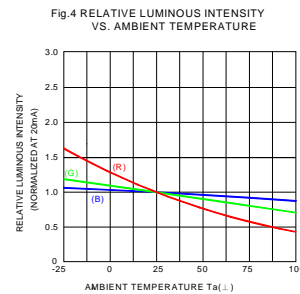
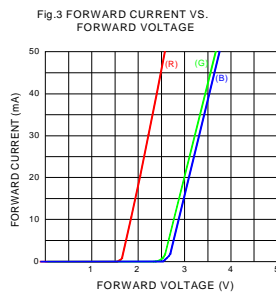
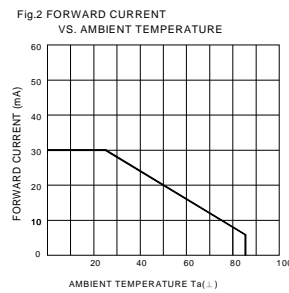
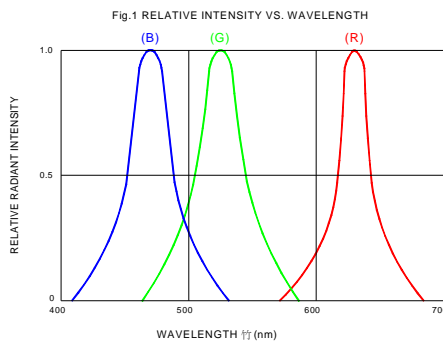

● Tapping and packaging specifications(Units: mm)

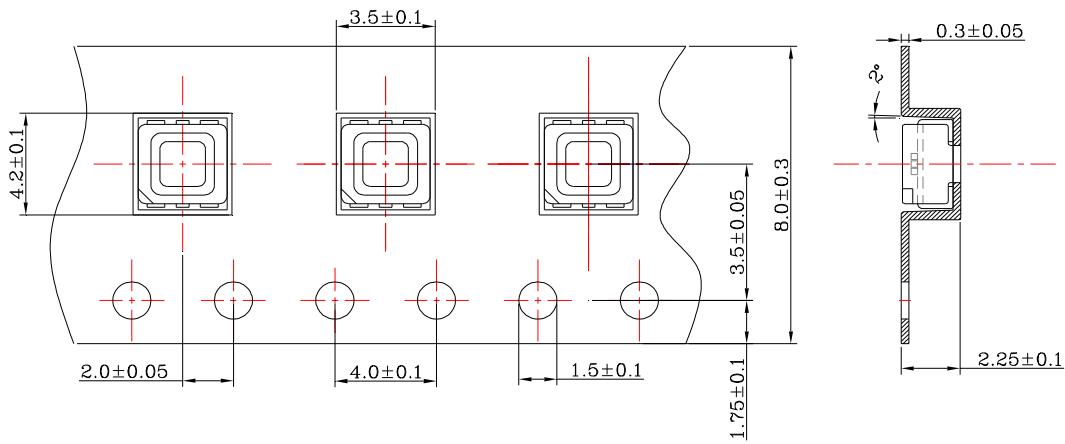

● Package Method:(unit:mm)

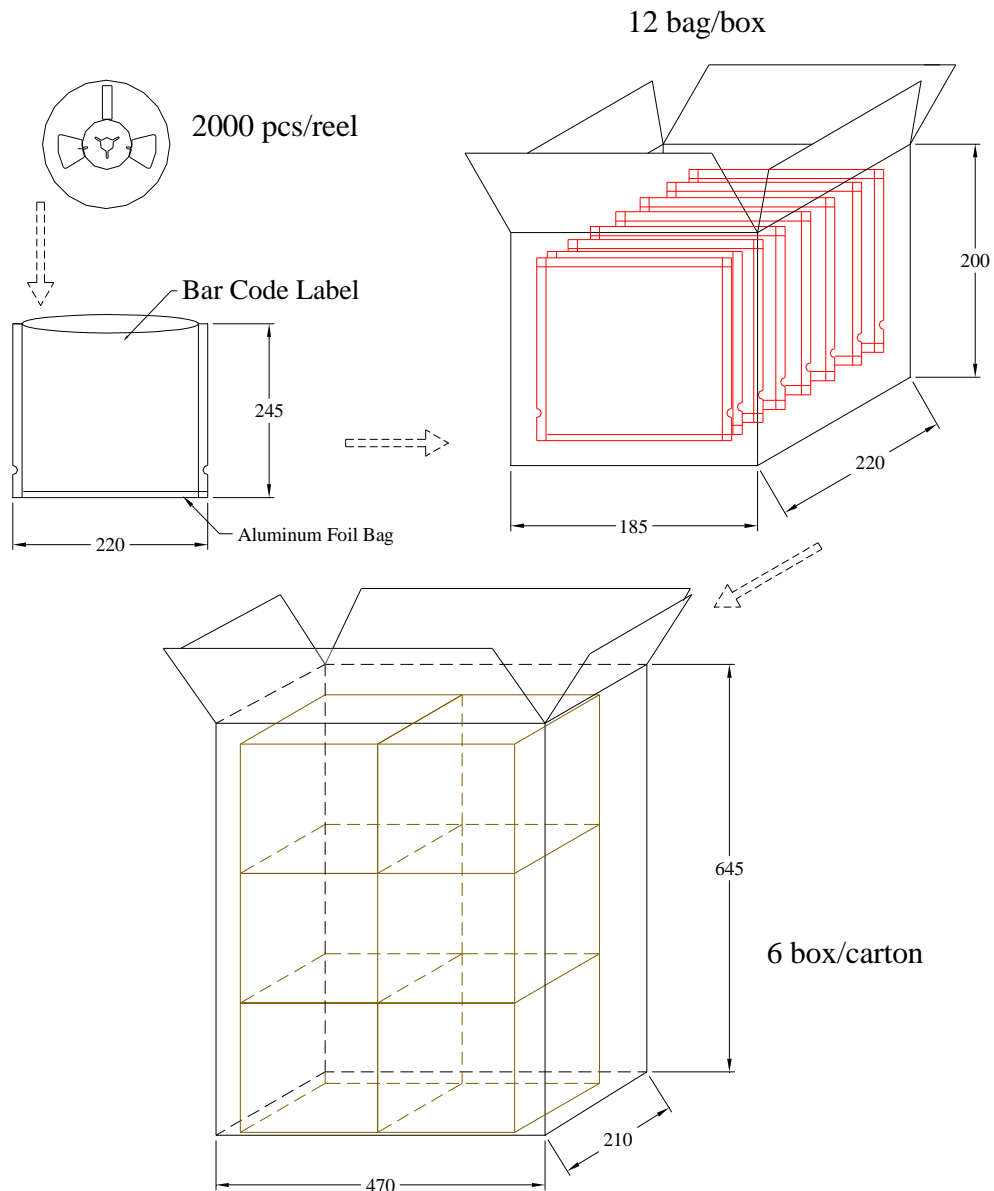

● Bin Limits (At 20mA)

Intensity Bin Limits (At 20 mA) (JX)

COLOR	RED			
ITEM	Iv (mcd)		λ d (nm)	
Spec	715-1600		619-630	
BIN	MIN	MAX	MIN	MAX
V	715	1070	619	630
W	1070	1600		

Intensity Bin Limits (At 20 mA) (GX)

COLOR	GREEN			
ITEM	Iv (mcd)		λ d (nm)	
Spec	1070-2400		520-530	
BIN	MIN	MAX	MIN	MAX
W6	1070	1600	520	525
W7			525	530
X6	1600	2400	520	525
X7			525	530

## Intensity Bin Limits (At 20 mA) (BX)

COLOR	BLUE			
ITEM	Iv (mcd)		$\lambda d$ (nm)	
Spec	210-715		460-475	
BIN	MIN	MAX	MIN	MAX
S3	210	317	460	465
S4			465	470
S5			470	475
T3	317	475	460	465
T4			465	470
T5			470	475
U3	475	715	460	465
U4			465	470
U5			470	475

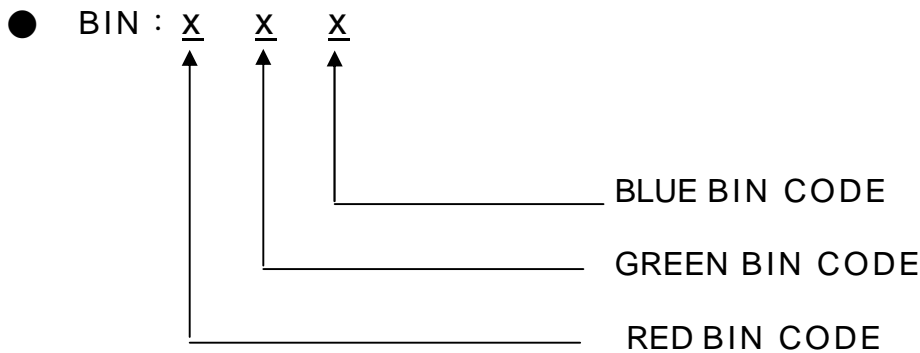

### Notes:

1. Iv : Tolerance for each Bin limit is  $\pm 10\%$
2.  $\lambda d$  : Tolerance for each Bin limit is  $\pm 1\text{nm}$
3. Bin categories are established for classification of products.  
Products may not be available in all bin categories.

### ● Reliability Test

Classification	Test Item	Reference Standard	Test Conditions	Result
Endurance Test	Operation Life	MIL-STD-750:1026 MIL-STD-883:1005 JIS-C-7021 :B-1	I <sub>F</sub> =20mA T <sub>a</sub> =Under room temperature Test time=1,000hrs	0/20
	High Temperature High Humidity Storage	MIL-STD-202:103B JIS-C-7021 :B-11	T <sub>a</sub> =+65°C±5°C RH=90%-95% Test time=240hrs	0/20
	High Temperature Storage	MIL-STD-883:1008 JIS-C-7021 :B-10	High T <sub>a</sub> =+85°C±5°C Test time=1,000hrs	0/20
	Low Temperature Storage	JIS-C-7021 :B-12	Low T <sub>a</sub> =-35°C±5°C Test time=1,000hrs	0/20
Environmental Test	Temperature Cycling	MIL-STD-202:107D MIL-STD-750:1051 MIL-STD-883:1010 JIS-C-7021 :A-4	-35°C ~ +25°C ~ +85°C ~ +25°C 60min 20min 60min 20min Test Time=5cycle	0/20
	Thermal Shock	MIL-STD-202:107D MIL-STD-750:1051 MIL-STD-883:1011	-35°C±5°C ~+85°C±5°C 20min 20min Test Time=10cycle	0/20
	Solder Resistance	MIL-STD-202:201A MIL-STD-750:2031 JIS-C-7021 :A-1	Preheating : 140°C-160°C, within 2 minutes. Operation heating : 260°C (Max.), within 10seconds. (Max.)	0/20

### ● Judgment criteria of failure for the reliability

Measuring items	Symbol	Measuring conditions	Judgment criteria for failure
Forward voltage	V <sub>F</sub> (V)	I <sub>F</sub> =20mA	Over U <sup>1</sup> x1.2
Reverse current	I <sub>R</sub> (uA)	V <sub>R</sub> =5V	Over U <sup>1</sup> x2
Luminous intensity	I <sub>v</sub> ( mcd)	I <sub>F</sub> =20mA	Below S <sup>1</sup> X0.5

Note: 1. U means the upper limit of specified characteristics. S means initial value.

2. After each test, remove test pieces, wait for 2 hours and test pieces have returned to ambient temperature, then take next measurement.

## ●IR-Reflow

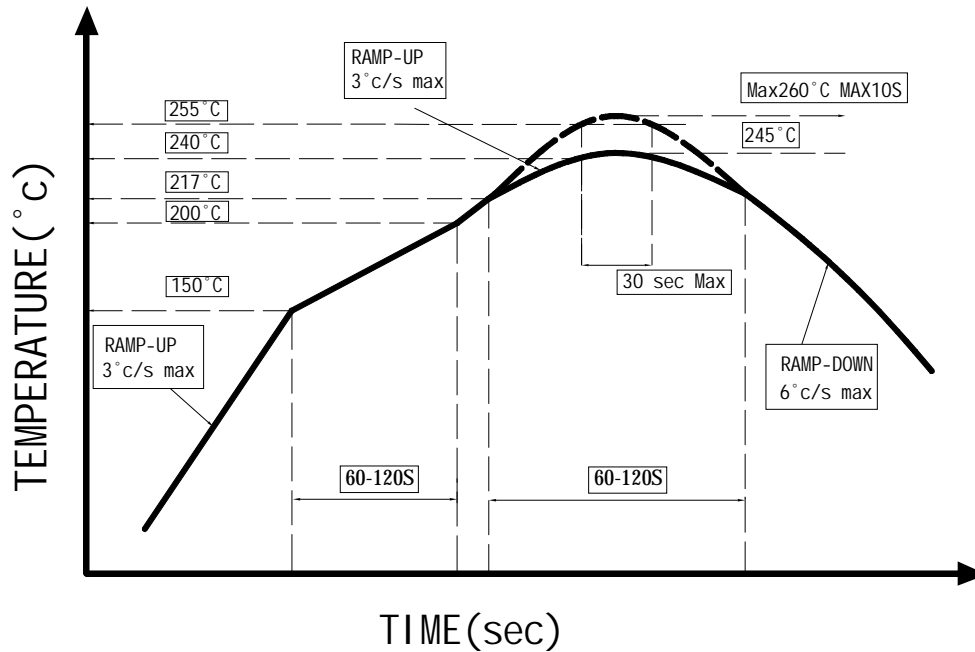

- 1、 Avoid any external stress applied to the resin while the LEDs are at high temperature, especially during soldering.
- 2、 Avoid rapid cooling or any excess vibration during temperature ramp-down process
- 3、 Although the soldering condition is recommended above, soldering at the lowest possible temperature is feasible for the LEDs

## ●IRON Soldering

350°C Within 3 sec, one time only.



### Handling Precautions

Compare to epoxy encapsulant that is hard and brittle, silicone is softer and flexible. Although its characteristic significantly reduces thermal stress, it is more susceptible to damage by external mechanical force.

As a result, special handling precautions need to be observed during assembly using silicone encapsulated LED products. Failure to comply might lead to damage and premature failure of the LED.

1. Handle the component along the side surfaces by using forceps or appropriate tools. (pic.1)
2. Do not directly touch or handle the silicone lens surface. It may damage the internal circuitry. (pic.2, pic.3)
3. Do not stack together assembled PCBs, containing exposed LEDs. Impact may scratch the silicone lens or damage the internal circuitry. (pic.4)
4. The outer diameter of the SMD pickup nozzle should not exceed the size of the LED to prevent air leaks. The inner diameter of the nozzle should be as large as possible. (pic.5)
5. A pliable material is suggested for the nozzle tip to avoid scratching or damaging the LED surface during pickup. (pic.5)
6. The dimensions of the component must be accurately programmed in the pick-and-place machine to insure precise pickup and avoid damage during production. (pic.5)

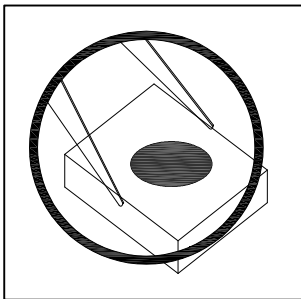

**Pic.1**

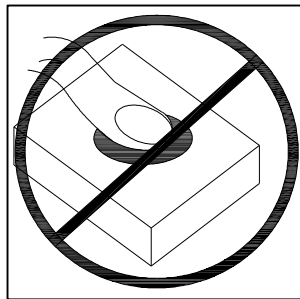

**Pic.2**

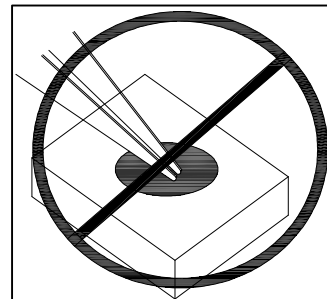

**Pic.3**

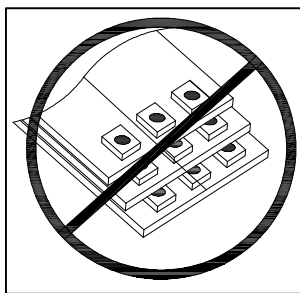

**Pic.4**

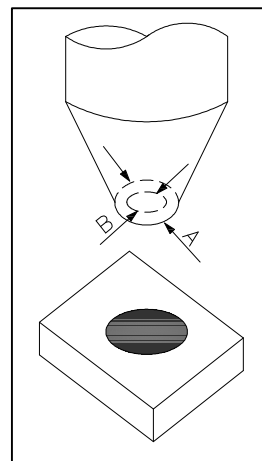

**Pic.5**

● **Notes for designing:**

Care must be taken to provide the current limiting resistor in the circuit so as to drive the LEDs within the rated figures. Also, caution should be taken not to overload LEDs with instantaneous voltage at the turning ON and OFF of the circuit.

When using the pulse drive care must be taken to keep the average current within the rated figures. Also, the circuit should be designed so as to be subjected to reverse voltage when turning off the LEDs.

● **Storage:**

In order to avoid the absorption of moisture, it is recommended to solder LEDs as soon as possible after unpacking the sealed envelope.

If the envelope is still packed, to store it in the environment as following:

- (1) Temperature : 5°C-30°C(41°F) Humidity : RH 60% Max.
- (2) After this bag is opened, devices that will be applied to infrared reflow, vapor-phase reflow, or equivalent soldering process must be:
  - a. Completed within 24 hours.
  - b. Stored at less than 20% RH.
- (3) Devices require baking before mounting, if:
  - 2a or 2b is not met.
- (4) If baking is required, devices must be baked under below conditions:
  - 48 hours at 60°C±5°C.

● **Package and Label of Products:**

- (1) Package: Products are packed in one bag of 2000 pcs (one taping reel) and a label is attached to each bag.
- (2) Label:

