



Specification for Approval

- DEVICE NUMBER: BL-HGX32X

SAMPLES
ATTACHED AREA

DATE \ PAGE	1	2	3	4	5	6	7	8			CONTENTS
2017.10.27	1.0	1.0	1.0	1.0	1.0	1.0	1.0	1.0			Initial Released

FOR CUSTOMER'S APPROVAL STAMP OR SIGNATURE

APPROVED	PURCHASE	MANUFACTURE	QUALITY	ENGINEERING

佰鴻工業股份有限公司
 BRIGHT LED ELECTRONICS CORP.
 新北市板橋區和平路 19 號 3 樓
 3F., No.19, He Ping Road,
 Ban Qiao Dist., New Taipei City,
 Taiwan
 Tel: +886-2-29591090
 Fax: +886-2-29547006/29558809
www.brtled.com

ISSUED	APPROVED	PREPARED
張孝嚴	陳悌帆	熊燦芬

● Features:

1. Emitted Color : Super Green.
2. Lens Appearance: Water Clear.
3. 3.5x2.8x1.85mm standard package.
4. Suitable for all SMT assembly methods.
5. Compatible with infrared and vapor phase reflow solder process.
6. Compatible with automatic placement equipment.
7. This product doesn't contain restriction Substance, comply ROHS standard.

● Applications:

1. Automotive: Dashboards, stop lamps, turn signals.
2. Backlighting: LCDs, Key pads advertising.
3. Status indicators: Consumer & industrial electronics.
4. General use.

● Package Dimensions:

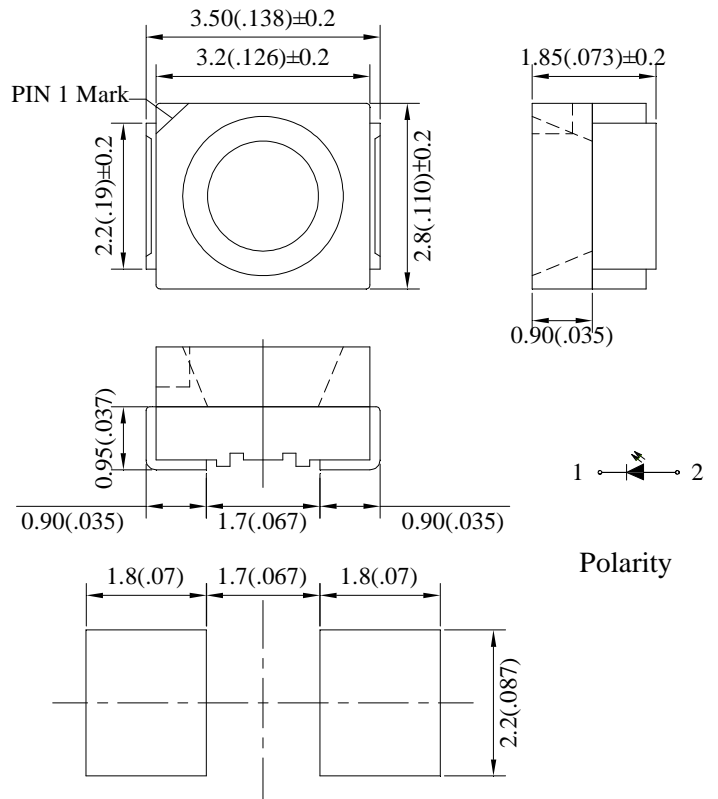

NOTES:

1. All dimensions are in millimeters (inches).
2. Tolerance is ±0.10mm (0.004") unless otherwise specified.
3. Specifications are subject to change without notice.

● Absolute Maximum Ratings(Ta=25°C)

Parameter	Symbol	Rating	Unit
Power Dissipation	Pd	108	mW
Forward Current	I _F	30	mA
Peak Forward Current * 1	I _{FP}	100	mA
Operating Temperature	Topr	-40°C ~85°C	-
Storage Temperature	Tstg	-40°C ~100°C	-
Soldering Temperature	Tsol	See Page 7	-

* 1 Condition for I_{FP} is pulse of 1/10 duty and 3 msec width.

● Electrical and optical characteristics(Ta=25°C)

Parameter	Symbol	Condition	Min.	Typ.	Max.	Unit
Forward Voltage	V _f	I _F =20mA	2.8	3.2	3.6	V
Luminous Intensity	I _v	I _F =20mA	-	2000	-	mcd
Reverse Current	I _R	V _R =5V	-	-	10	μA
Peak Wavelength	λ _p	I _F =20mA	-	525	-	nm
Dominant Wave Length	λ _d	I _F =20mA	520	-	530	nm
Spectral Line Half-width	Δλ	I _F =20mA	-	30	-	nm
Viewing Angle	2θ _{1/2}	I _F =20mA	-	120	-	deg

● Typical Electro-Optical Characteristics Curves

Fig.1 Relative intensity vs. wavelength

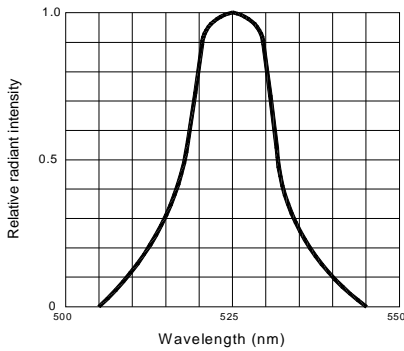

Fig.2 Forward current derating curve vs. ambient temperature

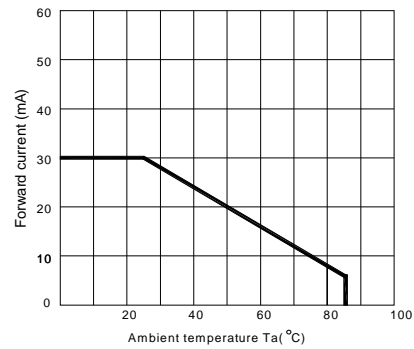

Fig.3 Forward current vs. forward voltage

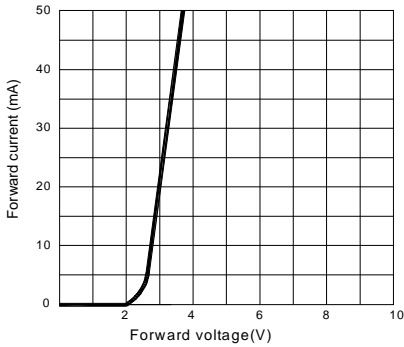

Fig.4 Relative luminous intensity vs. ambient temperature

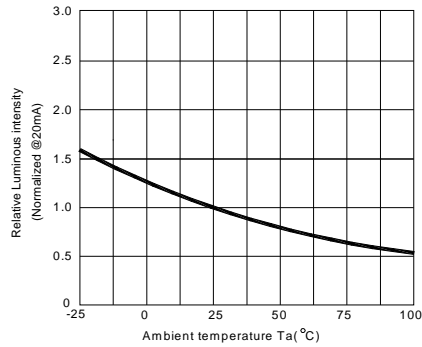

Fig.5 Relative luminous intensity vs. forward current

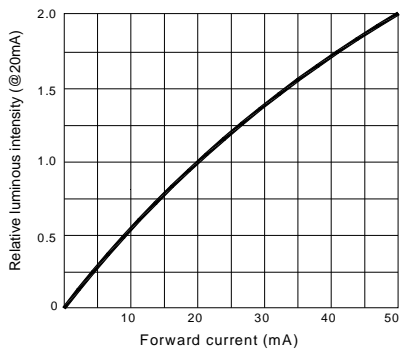
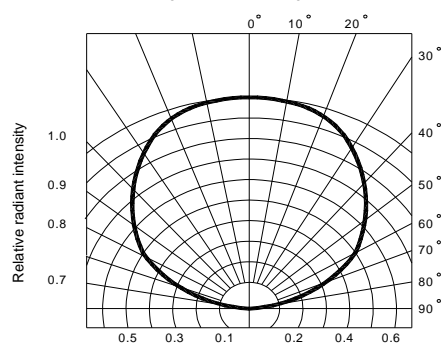
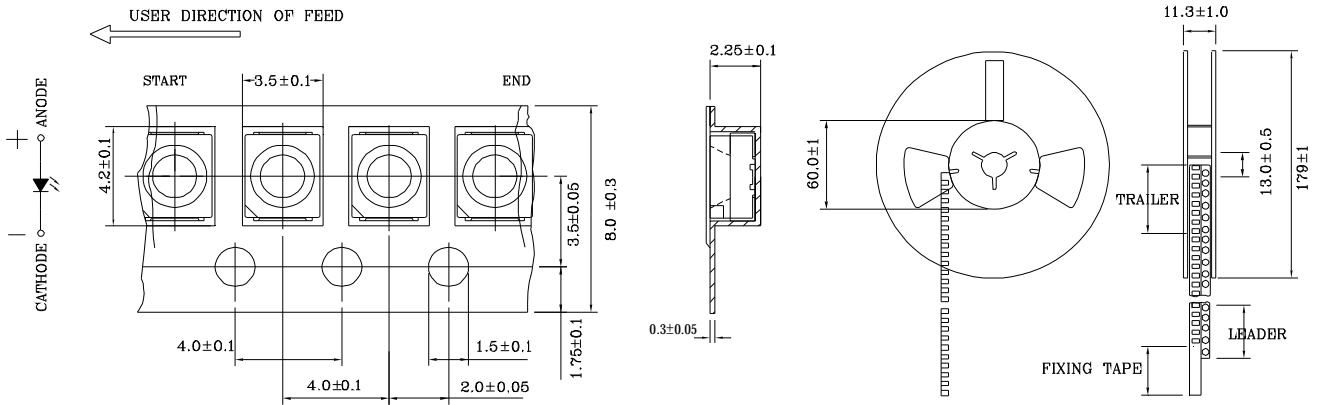

Fig.6 Radiation diagram



● Tapping and packaging specifications(Units: mm)



NOTE:2000 PCS PER REEL

● Package Method:(unit:mm)

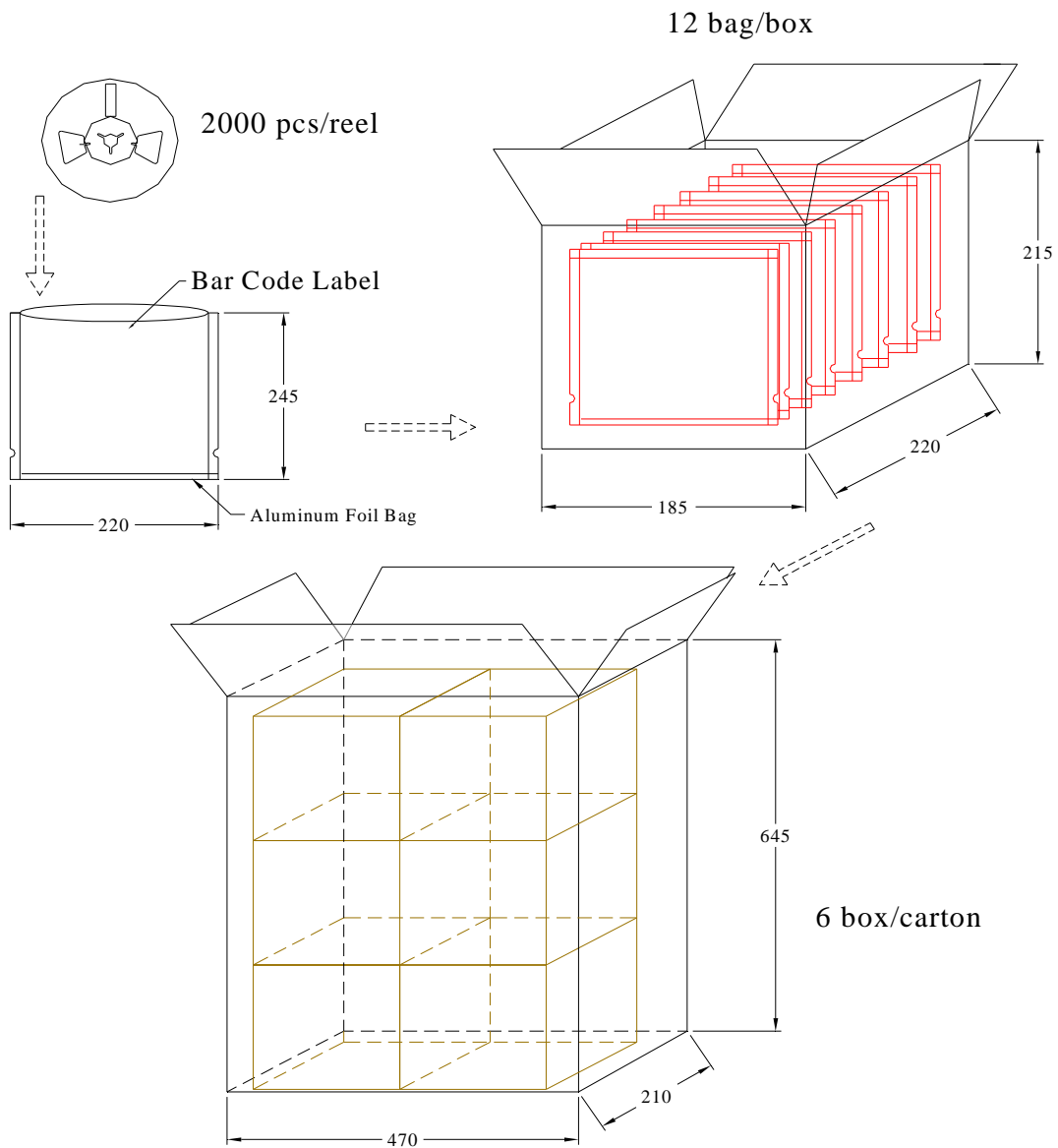

● **Bin Limits**

Intensity Bin Limits (At 20mA)

BIN CODE	Min. (mcd)	Max. (mcd)
W	1070	1600
X	1600	2400

Tolerance for each Bin limit is $\pm 15\%$.

Forward Voltage Bin Limits (At 20 mA)

BIN CODE	Min.(V)	Max.(V)
G	2.8	3.0
H	3.0	3.2
J	3.2	3.4
K	3.4	3.6

Tolerance for each Bin limit is $\pm 0.02V$.

Color Bin Limits (At 20 mA)

BIN CODE	Min. (nm)	Max. (nm)
6	520	525
7	525	530

Tolerance for each Bin limit is $\pm 1nm$

● BIN :

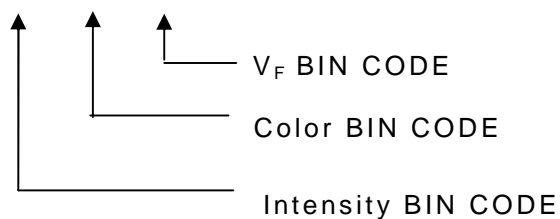

● Reliability Test

Classification	Test Item	Reference Standard	Test Conditions	Result
Endurance Test	Operation Life	MIL-STD-750:1026 MIL-STD-883:1005 JIS-C-7021 :B-1	Connect with a power $I_f=20\text{mA}$ T_a =Under room temperature Test time=1,000hrs	0/20
	High Temperature High Humidity Storage	MIL-STD-202:103B JIS-C-7021 :B-11	$T_a=+65^\circ\text{C}\pm 5^\circ\text{C}$ RH=90%-95% Test time=240hrs	0/20
	High Temperature Storage	MIL-STD-883:1008 JIS-C-7021 :B-10	High $T_a=+85^\circ\text{C}\pm 5^\circ\text{C}$ Test time=1,000hrs	0/20
	Low Temperature Storage	JIS-C-7021 :B-12	Low $T_a=-35^\circ\text{C}\pm 5^\circ\text{C}$ Test time=1,000hrs	0/20
Environmental Test	Temperature Cycling	MIL-STD-202:107D MIL-STD-750:1051 MIL-STD-883:1010 JIS-C-7021 :A-4	$-35^\circ\text{C} \sim +25^\circ\text{C} \sim +85^\circ\text{C} \sim +25^\circ\text{C}$ 60min 20min 60min 20min Test Time=5cycle	0/20
	Thermal Shock	MIL-STD-202:107D MIL-STD-750:1051 MIL-STD-883:1011	$-35^\circ\text{C}\pm 5^\circ\text{C} \sim +85^\circ\text{C}\pm 5^\circ\text{C}$ 20min 20min Test Time=10cycle	0/20
	Solder Resistance	MIL-STD-202:201A MIL-STD-750:2031 JIS-C-7021 :A-1	Preheating : 140°C-160°C, within 2 minutes. Operation heating : 260°C (Max.), within 10seconds. (Max.)	0/20

● Judgment criteria of failure for the reliability

Measuring items	Symbol	Measuring conditions	Judgement criteria for failure
Forward voltage	V_F (V)	$I_F=20\text{mA}$	Over $U \times 1.2$
Reverse current	I_R (μA)	$V_R=5\text{V}$	Over $U \times 2$
Luminous intensity	I_v (mcd)	$I_F=20\text{mA}$	Below $S \times 0.5$

Note: 1.U means the upper limit of specified characteristics. S means initial value.

2.Measurment shall be taken between 2 hours and after the test pieces have been returned to normal ambient conditions after completion of each test.

●IR-Reflow

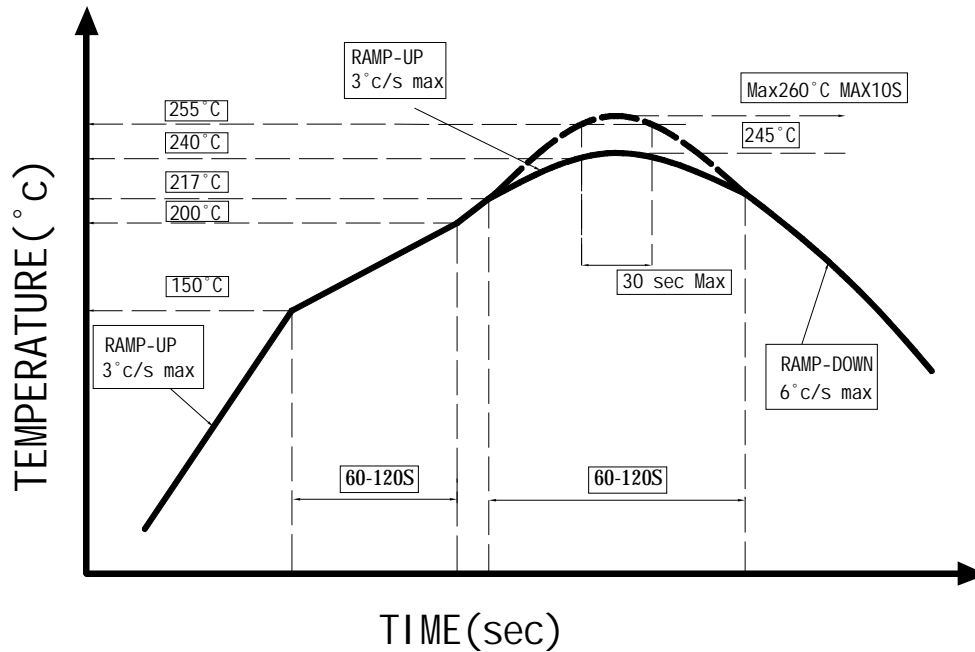

- 1、 Avoid any external stress applied to the resin while the LEDs are at high temperature, especially during soldering.
- 2、 Avoid rapid cooling or any excess vibration during temperature ramp-down process
- 3、 Although the soldering condition is recommended above, soldering at the lowest possible temperature is feasible for the LEDs

●IRON Soldering

350°C Within 3 sec, one time only.

Handling Precautions

Compare to epoxy encapsulant that is hard and brittle, silicone is softer and flexible. Although its characteristic significantly reduces thermal stress, it is more susceptible to damage by external mechanical force.

As a result, special handling precautions need to be observed during assembly using silicone encapsulated LED products. Failure to comply might lead to damage and premature failure of the LED.

1. Handle the component along the side surfaces by using forceps or appropriate tools. (pic.1)
2. Do not directly touch or handle the silicone lens surface. It may damage the internal circuitry. (pic.2, pic.3)
3. Do not stack together assembled PCBs, containing exposed LEDs. Impact may scratch the silicone lens or damage the internal circuitry. (pic.4)
4. The outer diameter of the SMD pickup nozzle should not exceed the size of the LED to prevent air leaks. The inner diameter of the nozzle should be as large as possible. (pic.5)
5. A pliable material is suggested for the nozzle tip to avoid scratching or damaging the LED surface during pickup. (pic.5)
6. The dimensions of the component must be accurately programmed in the pick-and-place machine to insure precise pickup and avoid damage during production. (pic.5)

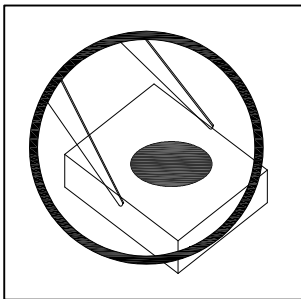

Pic.1

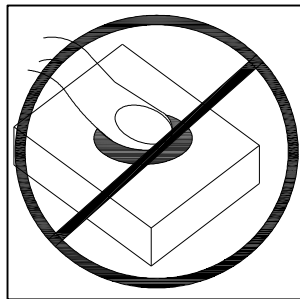

Pic.2

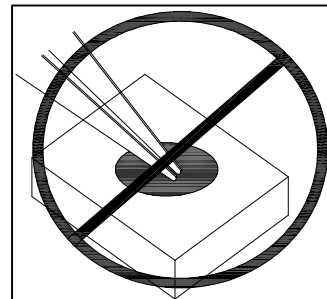

Pic.3

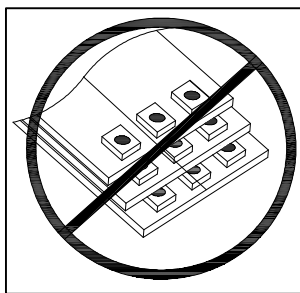

Pic.4

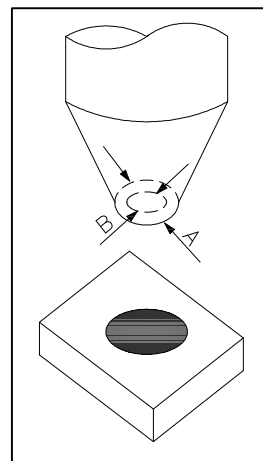

Pic.5

● Notes for designing:

Care must be taken to provide the current limiting resistor in the circuit so as to drive the LEDs within the rated figures. Also, caution should be taken not to overload LEDs with instantaneous voltage at the turning ON and OFF of the circuit.

When using the pulse drive care must be taken to keep the average current within the rated figures. Also, the circuit should be designed so as to be subjected to reverse voltage when turning off the LEDs.

● Storage:

In order to avoid the absorption of moisture, it is recommended to solder LEDs as soon as possible after unpacking the sealed envelope.

If the envelope is still packed, to store it in the environment as following:

- (1) Temperature : 5°C-30°C(41°F) Humidity : RH 60% Max.
- (2) After this bag is opened, devices that will be applied to infrared reflow, vapor-phase reflow, or equivalent soldering process must be:
 - a. Completed within 24 hours.
 - b. Stored at less than 20% RH.
- (3) Devices require baking before mounting, if:
 - 2a or 2b is not met.
- (4) If baking is required, devices must be baked under below conditions:
 - 48 hours at 60°C±5°C.

● Package and Label of Products:

- (1) Package: Products are packed in one bag of 2000 pcs (one taping reel) and a label is attached on each bag.
- (2) Label:

